

Soil Plate
1/4" steel

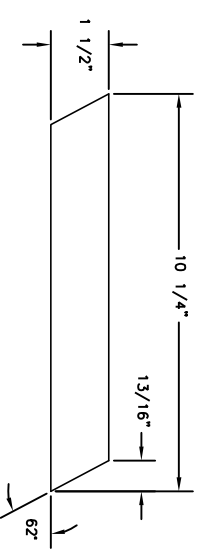

Side Angle
1/4" steel, 2x

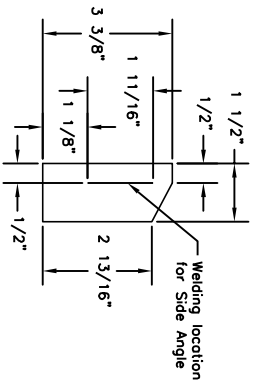

Vertical Plate
3/8" steel

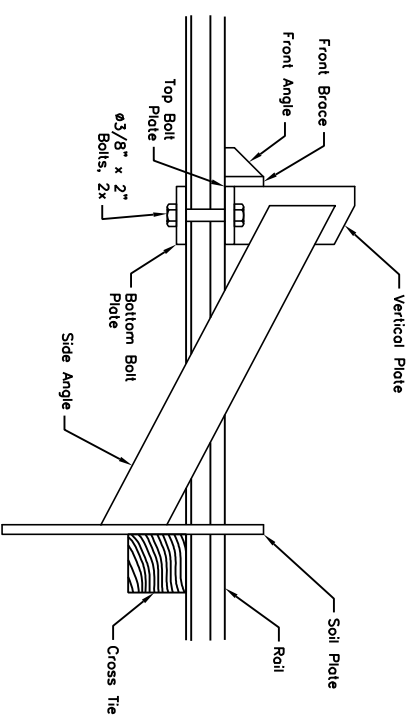
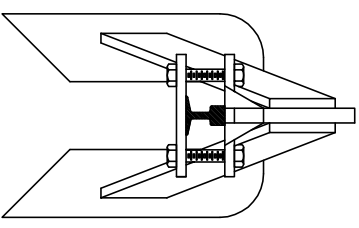

Bottom Bolt Plate
1/4" steel

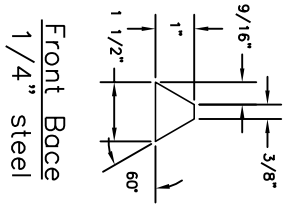
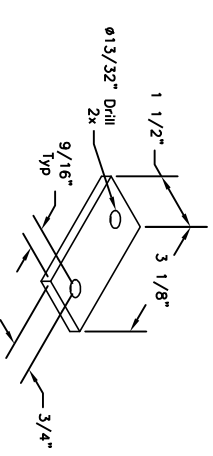

Front Base
1/4" steel

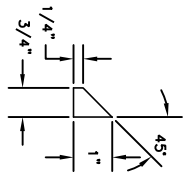

Front Angle
3/8" steel

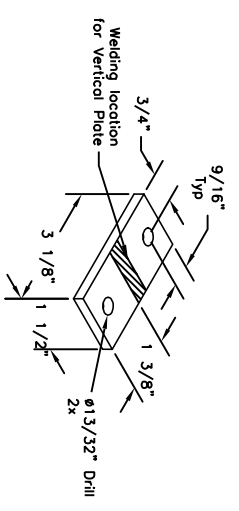

Top Bolt Plate
1/4" steel

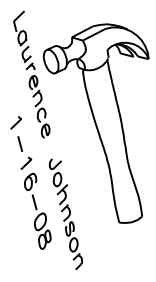

NOTE: Image quality is best when printed at 11 x 17". If you print on smaller paper, you may find it helpful to change the printer properties from "normal" to "fine"

<p>JOHNSONS SERVICE Back Yard Train © 2008 Lawrence Johnson, Back Yard Train. All rights reserved.</p>	
<h1>Wheel Stop</h1>	
DRAWN BY 	FILE NAME E:\TRAIN\wheel stop.dwg
SCALE NONE	DATE 1-12-08
SHEET 1	OF 1